



Easy to Install
安装简便



UV Protection
抗紫外线



Energy-saving
节能环保



Light & Durability
轻质耐久

LIXIN® Permanent
Excellent Quality
Just Need Time to Prove

历新® PC强力结构7层插接板(W500) Plug-pattern Sheet (PPS)



Ideas for Growth

Advocates of Advanced Lighting & Energy-saving
先进采光节能方案的倡导者

UV强光手电照射对比

UV layer check under UV flashlight

板材表面是否共挤有UV层，一般需要专用UV仪进行检测，普通用户在自然光下肉眼很难识别。UV强光手电可以帮助用户解决这个难题。

Usually it's difficult to see whether there is a coextruded UV layer on the sheet under natural light. UV flashlight helps you solve this problem.



A 板材表面没有共挤UV，经照射看不出有明显的特征。
No UV layer, no silver line under UV flashlight.



B 采用强光手电对板材横截面进行照射，与板材其它部分相比，UV层会变得明亮许多，仿佛板材表面镶了一道银边，且能清晰的看出UV分布是否均匀。

The UV layer becomes brighter than other part under UV flashlight. You can even see how thick and flat the UV was by the silver line.



可选附加功能 Options



Solar-Control
红外光控

历新-红外光控系列板材采用特殊的原料改性技术(金属反射、珠光反射、红外吸收),使得板材具有远红外屏蔽功能,它能有效阻挡或吸收太阳光谱中远红外热能,明显降低用于建筑的温控及照明成本,营造更为舒适的室内环境。
Lixin solar-control sheet applies resin-modified technology (three different solar smart types). It can effectively block the infrared heat while let in the visible light, significantly reducing the building energy cost and creating more comfortable indoor environment.



Crystal effect
晶亮效果

历新多层中空板在保持高透光率的同时,采用专用BAYER晶亮母粒改性,它的内壁颗粒效果改变了普通板材因光线折射形成的刺眼光带,从而使阳光变得柔和和不刺眼。
Lixin-Multi-wall polycarbonate glittering sheet using special BAYER bright master batch modified, while maintaining high light transmittance, its inner walls particles changing the glare light which caused by refraction, make the sun light soft and not dazzling.



Light Diffuse
光扩散

针对不同的透光率和雾度要求,历新光扩散板能提供多种规格和参数的产品。比如,有些应用对光扩散的要求不高,只需要柔和背光源轮廓,有些应用对光扩散的要求很高,以避免眩光直射。历新光扩散板给到设计师更多的选择性和灵活性,更好的满足各种特定需求。
Lixin Diffusive Sheet offers many light diffusion levels to help achieve the desired lighting qualities. Some designs, for example, may want a low level of diffusion to soften the edges of emitted light. Others may need more light diffusion to reduce direct glare. Having these diffusion options allows designers the ability to achieve the lighting qualities they desire for a specific fixture.



Matt UV
亚光UV

历新-表面哑光技术采用原装进口哑光材料对板材表面原料改性,它能有效阻隔紫外线对板材的伤害,还能使板材表面具有柔和的光学效果,对外有效减少光反射,对内杜绝眩光的产生,减少光污染。多种色系能符合设计师的不同建筑创意需求。

Lixin matt-uv sheet using imported resin modify technology, it can effectively block the sheet damage caused by UV radiation. The matt-UV coextruded on the surface of Lixin sheet will not only protect the sheet from aging, but also prevent glaring effect. Matt-UV can be customized to different color as you like.

以上附加功能有的可单独,有的可组合实现。附加功能的不同也可能导致产品成本的变化。欲知更多技术或商务信息,敬请致电正兴客服热线400-666-1197。我方人员将竭诚为您服务。

You can have one or more above options to fulfill your requirement. Different options may come with different cost. For more information, please feel free to contact us.

插接板标准参数 Production Standards & Technical Features

产品结构 Structure

插接板 7层菱形结构 7 Wall Plug-pattern shee

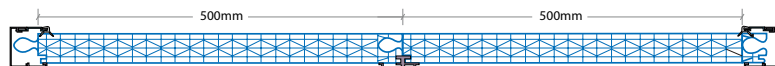

型号 Grade Name	LGL40T7DS4800
板材厚度 Thickness	40mm
重量 Weight	4.8 kg/m ²
透光率(透明板) Light Transmission (Clear)	55%
热导系数(U值) U-value	1.1W/m ² ·K
尺寸规格 Size	宽度Width: 500mm 长度Length: 6000、1200mm,特殊定制长度不限
线性膨胀系数 Linear thermal Expansion	10 ⁻⁵ /°C
温度范围 Temperature Range	-50°C~+120°C
屈服拉伸强度 Tensile Strength	62 Mpa
断裂延伸率 Elongation at Break	>80 %

板材常规颜色 Color

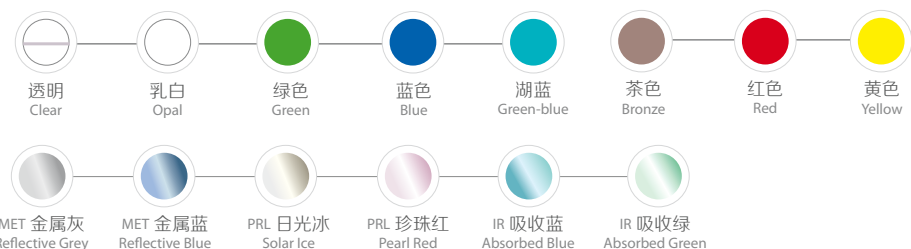

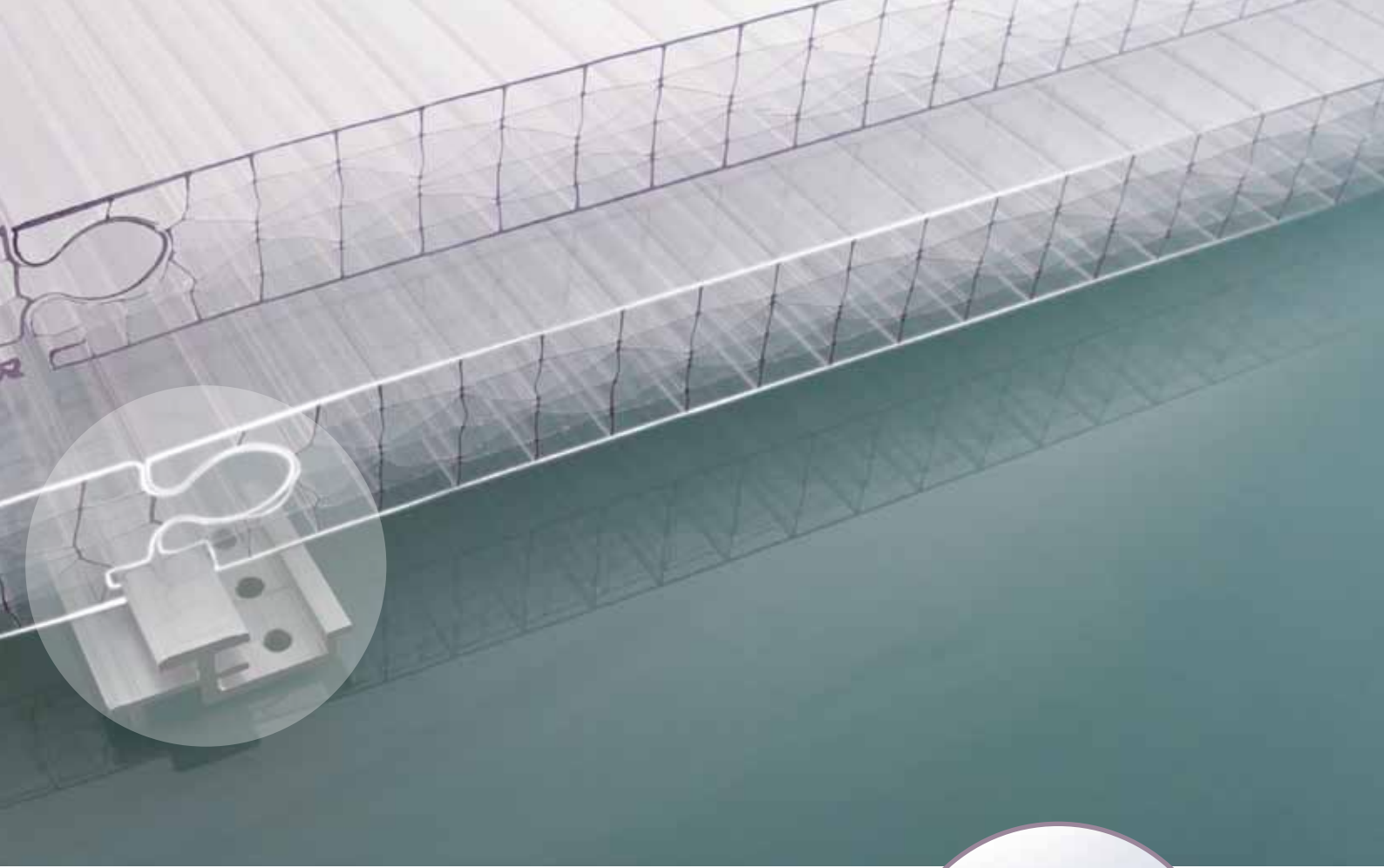

历新-7层菱形插接板

Lixin -7 Wall Plug-pattern sheet

历新-7层菱形插接板采用进口支链结构纯新聚碳酸酯原料制造。多层菱形使得产品结构强度稳定，保温隔热效果极佳，创新的插接口设计使得安装极为简便，广泛应用于飞机库，采光幕墙，室内隔断及高侧窗。通过原料特殊改性，可满足客户对红外隔热，晶亮效果，防雾滴、表面哑光等多种不同功能要求。

Lixin -7 Wall Plug-pattern sheet produced by pure virgin import polycarbonate resin. Multi diamond structure very stable, with extreme thermal insulation character. Plug design make the installation so easy. Wildly used on Hanger, facade, internal partition and high side window. According special Modification this products could meet difference's surface function requirement such as IR instillation, Glittering effect, Anti-drop and matte surface.

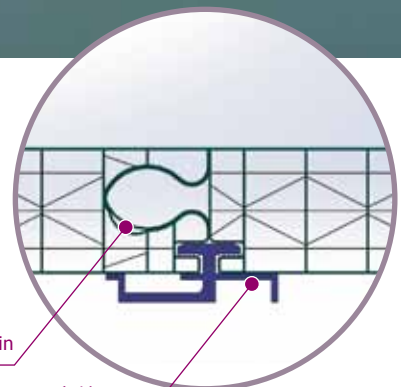

导水槽
Water drain

加厚固定件
T fastener

典型应用：
高侧窗、室内隔断、
机库移门、采光外墙
景观立面

Application:
High side window, internal
partition, Hangar
sliding door, lighting
facade, Landscape facade.





出色的美学效果

LIXIN历新-聚碳酸酯插接板采用全新设计的七层菱形结构，非常适合建筑外立面及室内隔断。内置椭圆形插口连接使板材表面不需要增加垂直固定型材轮廓，因此减少了安装成本并增强整体美感，极好的印刷性能及色彩的多样性可帮您的建筑实现多种美观的个性化效果。

Excellent aesthetic effect

Lixin plug-pattern sheet is new designed 7-layered diamond structure. It is easy to install, applied in curtain wall and indoor partition with elegant appearance and excellent heat resistance. Because of built-in oval plug structure, it requires less profiles when installed. Lixin® plug-pattern sheet can be directly printed with picture and word, achieving different architectural effect.

安装节点图

Installation Guide

典型节点1-墙体安装

板长≤6m时

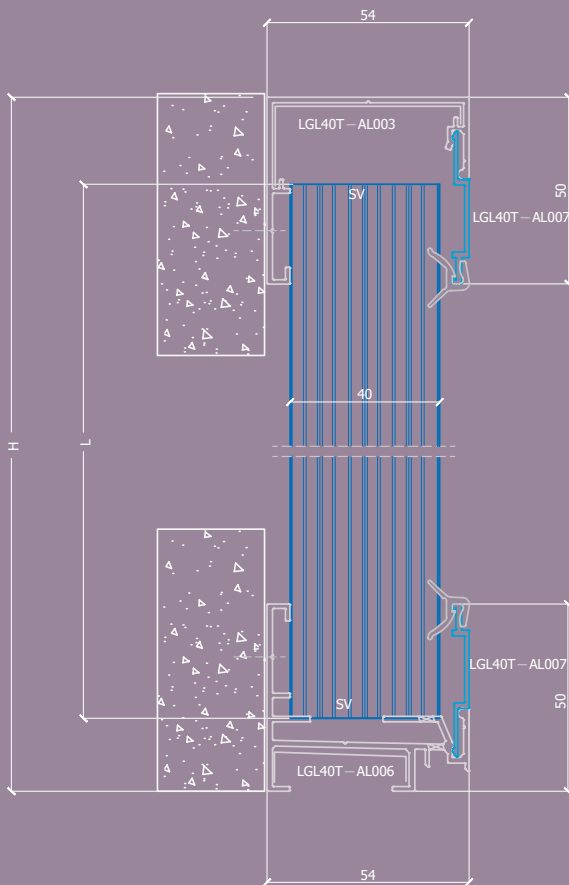

典型节点1-墙体安装

板长≤12m时

注释：特殊情况按安装现场条件，最长安装长度至17mm

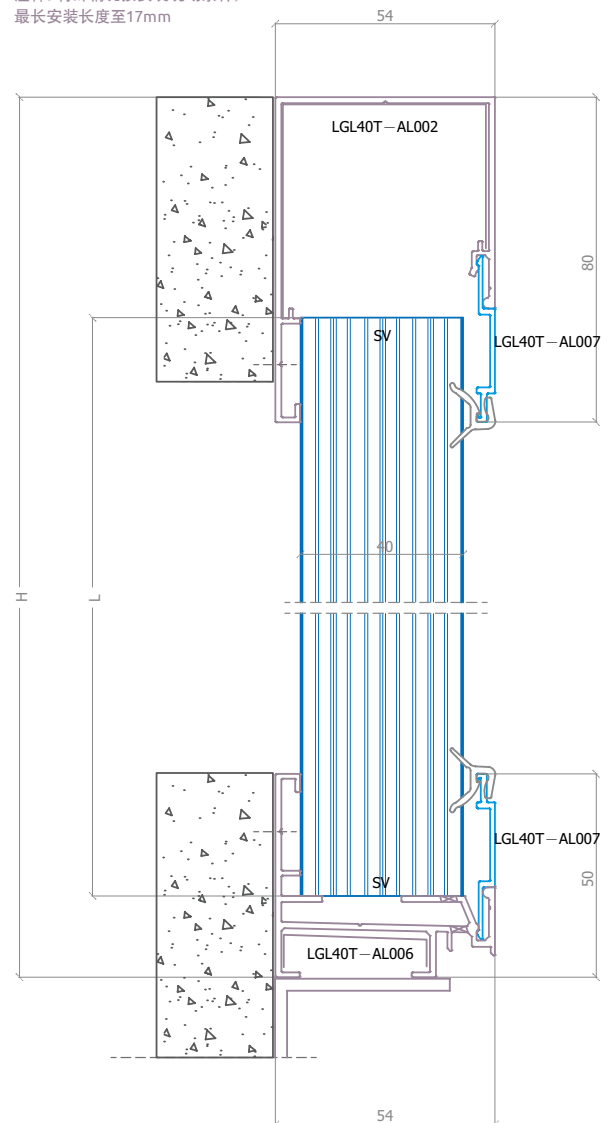



典型节点2-安装连接

- 1、板长 $\leq 6m$ ，带开口插条安装
- 2、板长 $\leq 6m$ ，带开口中间连接

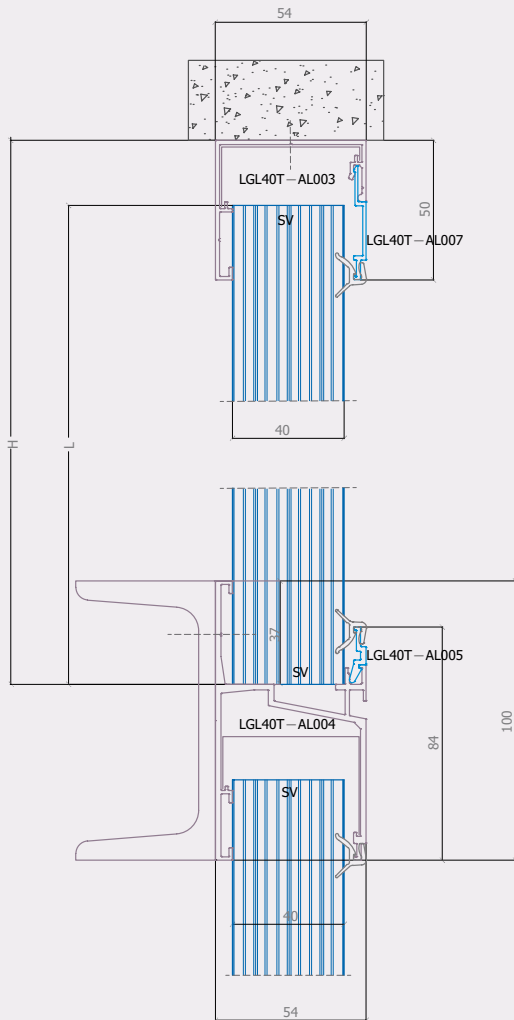

典型节点2-安装连接

- 1、板长6m不带开口插条
- 2、板长6m中间连接

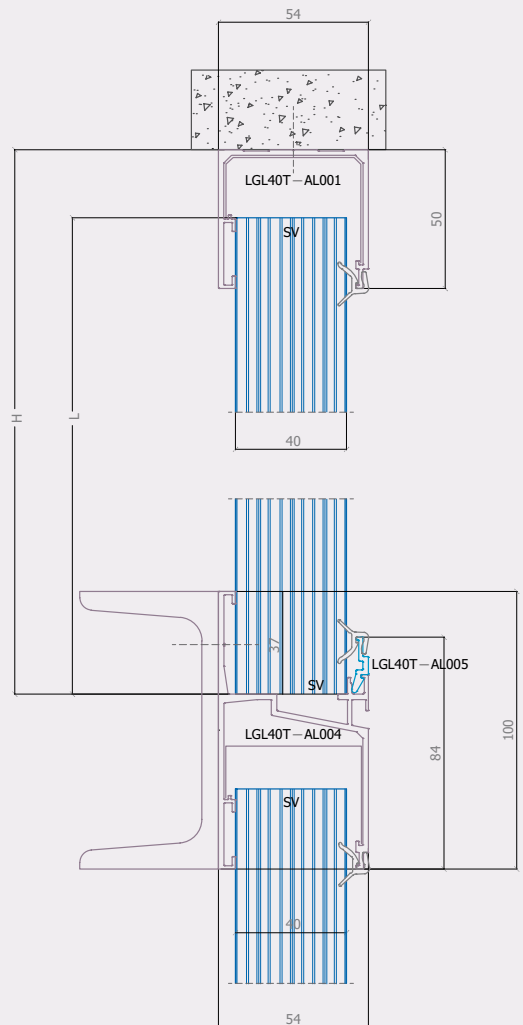

典型节点3-泛水板处理

板长6m及泛水板节点处理

- 01 46MM铝型材单体底框 LGL40T-AL010
- 02 橡胶条 LGL-EM001
- 03 铝型材底框固定条 LGL40T-AL011
- 04 LGL40T-AL012-150

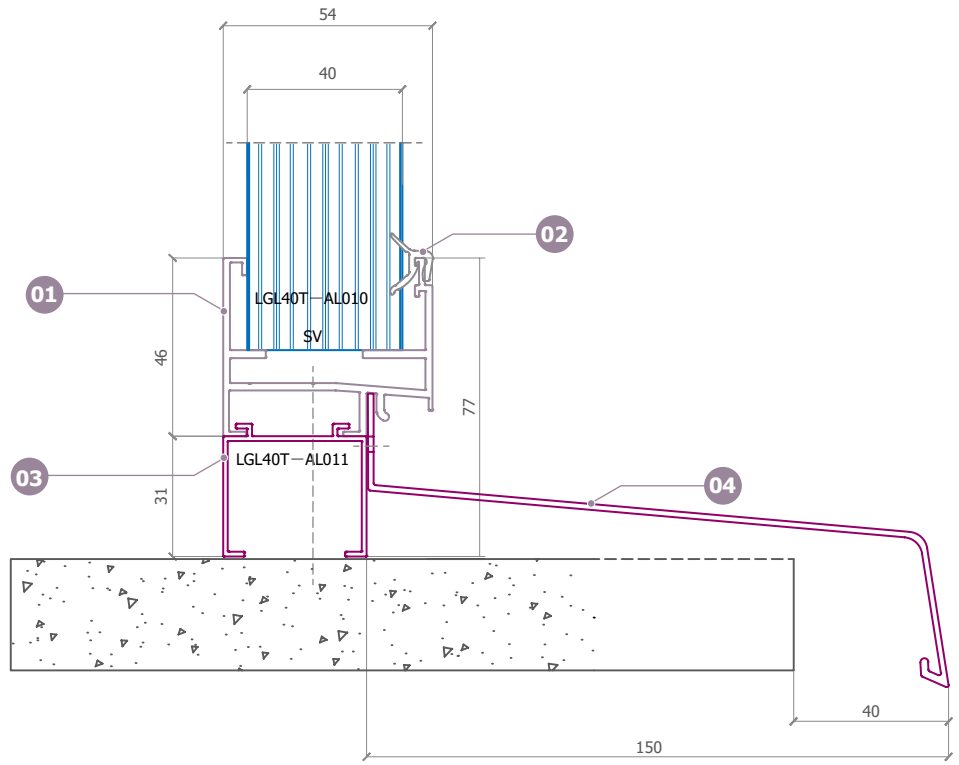

典型节点3-泛水板处理

板长12m及泛水节点处理

- 01 46MM铝型材底框 LGL40T-AL008
- 02 橡胶条 LGL-EM001
- 03 铝型材底框插条 LGL40T-AL009
- 04 铝型材底框固定条 LGL40T-AL011
- 05 LGL40T-AL012-130

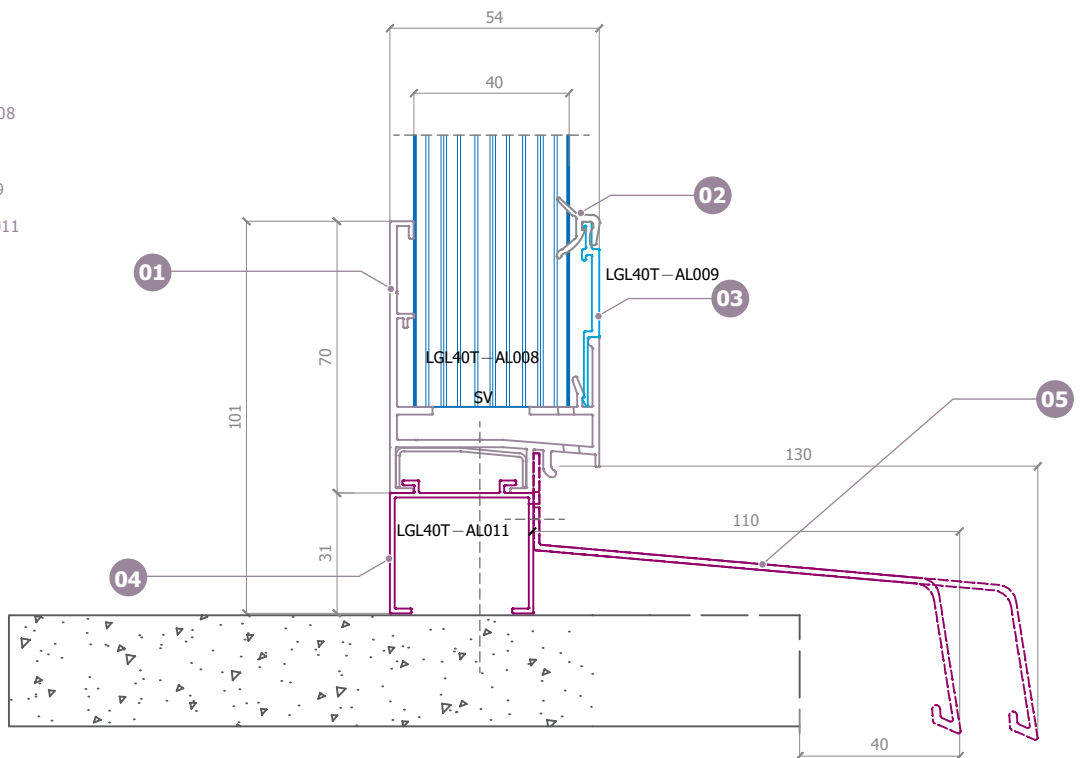

装配节点 Assembling Node

安装轴测效果图

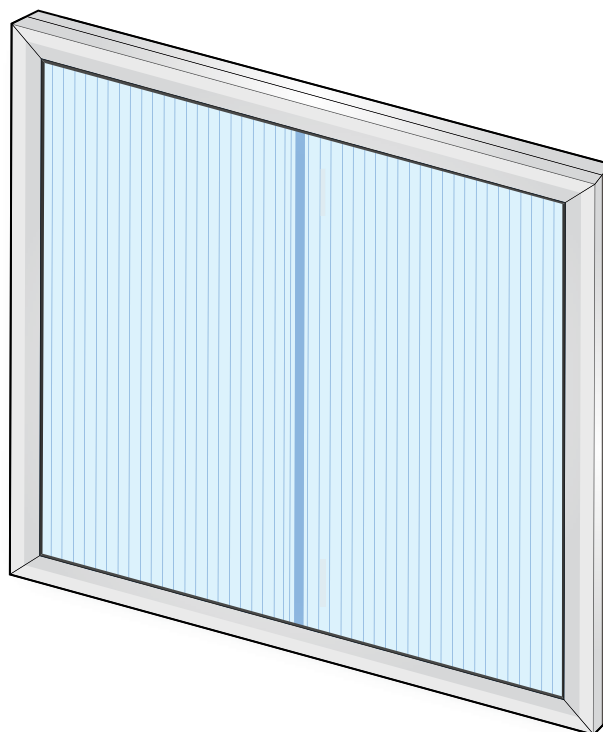

安装正面效果图

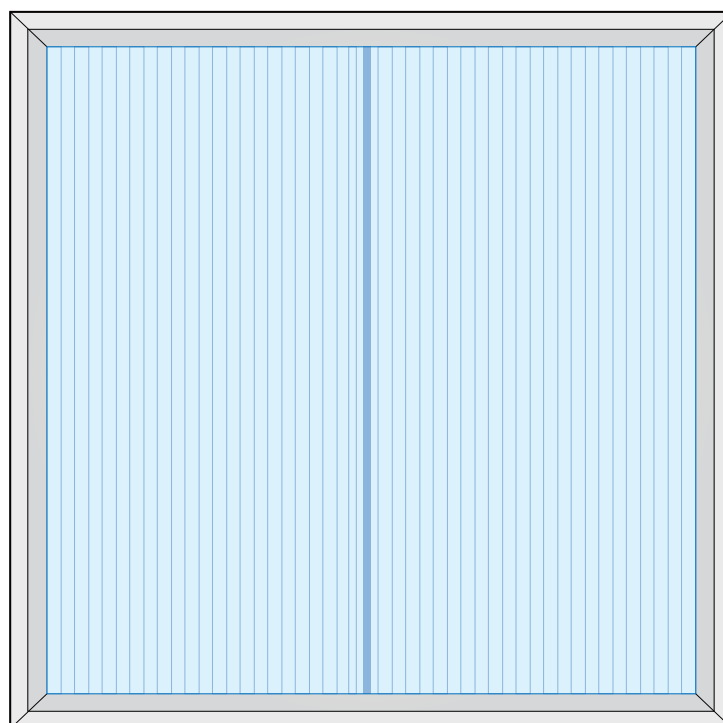

安装背面效果图

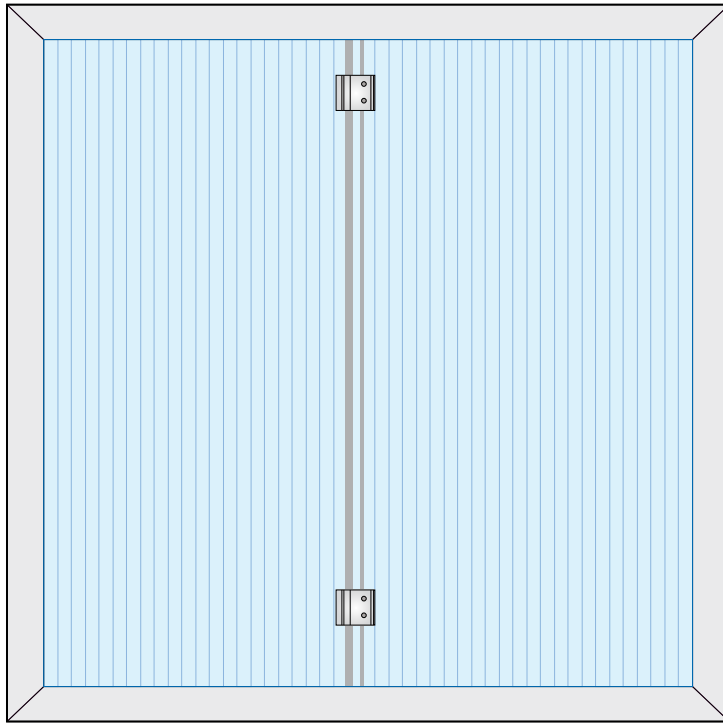

安装剖面效果图

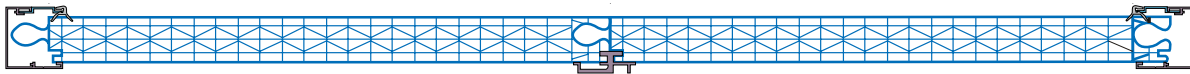

安装爆炸效果图

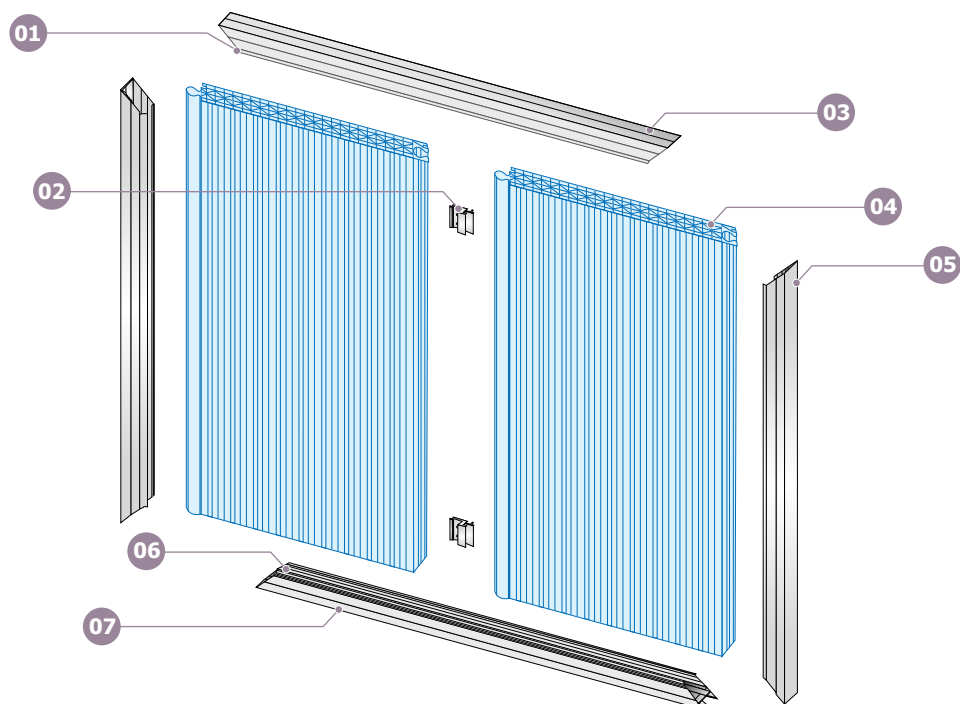

- 01 铝型材插条 LGL-AL007
- 02 铝型材固定座 LGL-AL012
- 03 铝型材上框 LGL-AL003
- 04 40MM插接板 LGL40T7DS4800
- 05 铝型材立框 LGL-AL003
- 06 橡胶条 LGL-EM001
- 07 铝型材下框 LGL-AL006

安装局部爆炸效果图

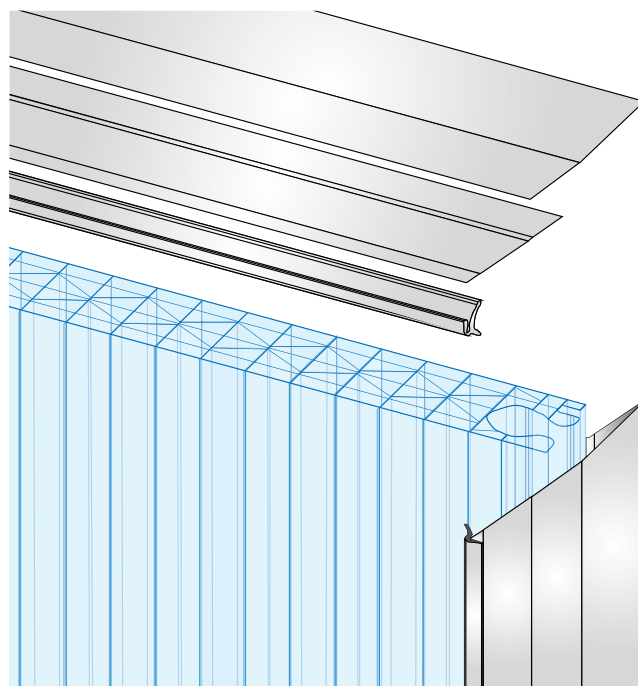

插接板固定效果图

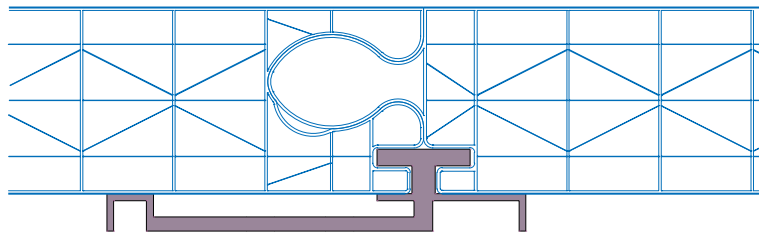

安装上框效果图

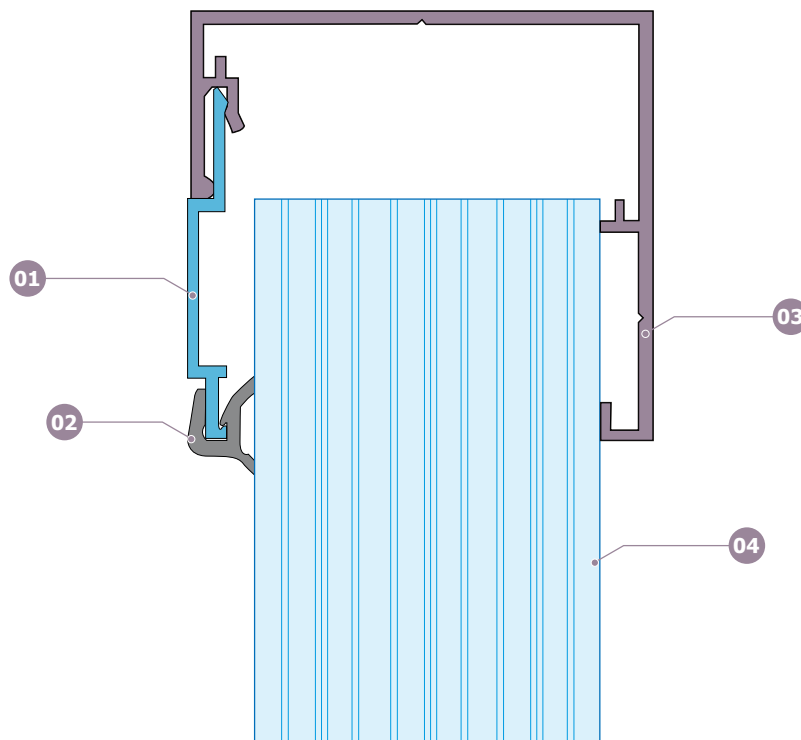

- 01 铝型材插条 LGL-AL007
- 02 橡胶条 LGL-EM001
- 03 50MM铝型材上框 LGL-AL003
- 04 40MM插接板 LGL40T7DS4800

安装竖框效果图

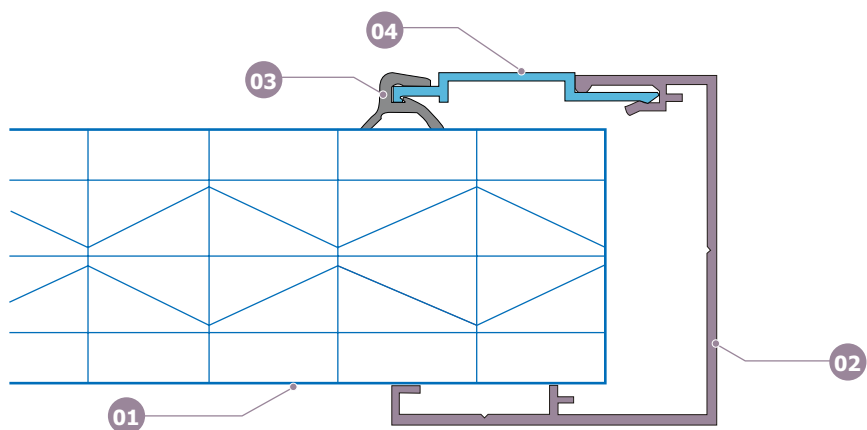

- 01 40MM插接板 LGL40T7DS4800
- 02 50MM铝型材上框 LGL-AL003
- 03 橡胶条 LGL-EM001
- 04 铝型材插条 LGL-AL007

安装下框效果图

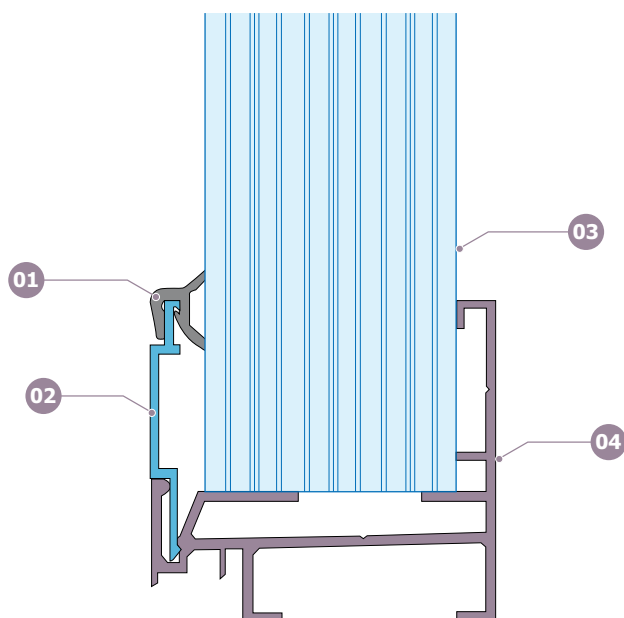

- 01 橡胶条 LGL-EM001
- 02 铝型材插条 LGL-AL007
- 03 40MM插接板 LGL40T7DS4800
- 04 50MM铝型材上框 LGL-AL003

连接安装爆炸效果图

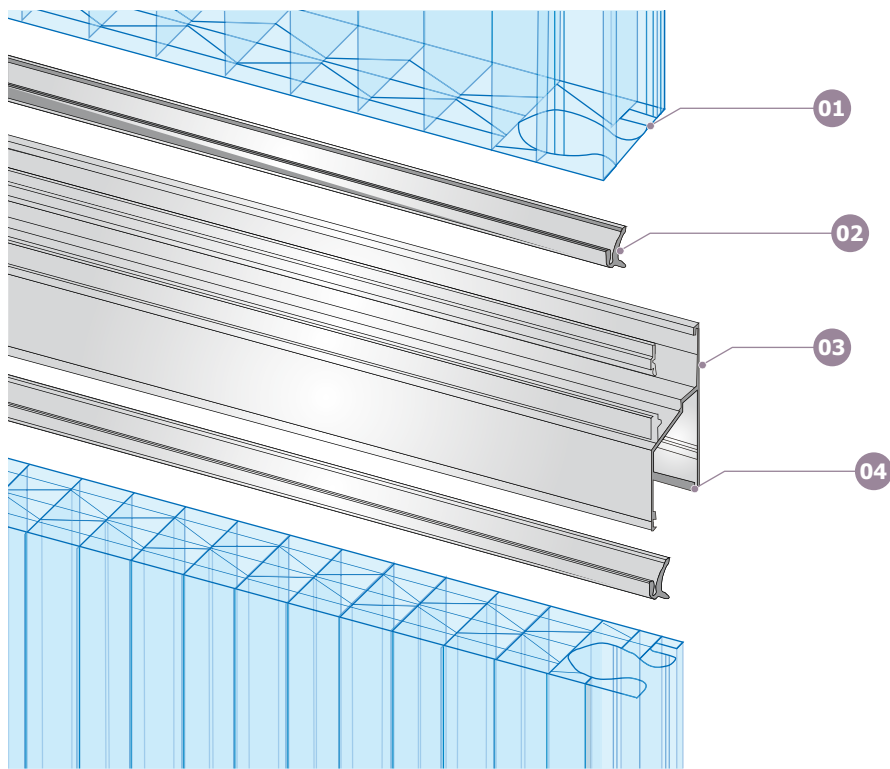

- 01 40MM插接板 LGL40T7DS4800
- 02 橡胶条 LGL-EM001
- 03 铝型材插条 LGL-AL005
- 04 铝型材连接框 LGL-AL004

连接安装剖面效果图

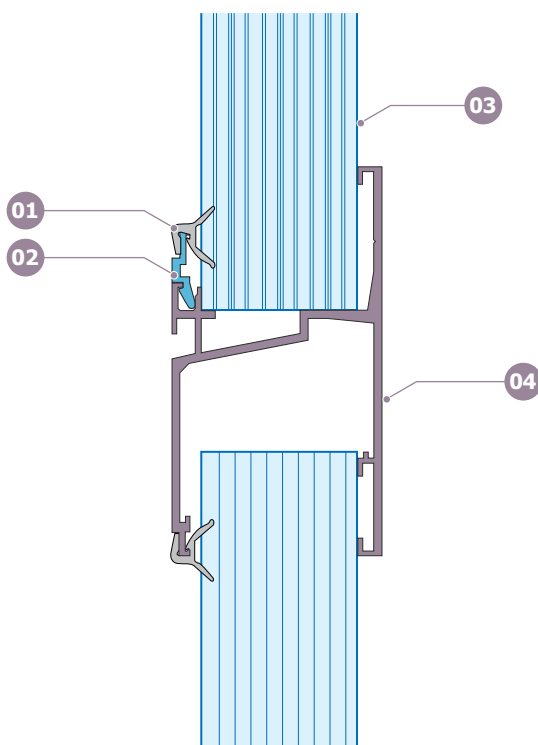

- 01 橡胶条 LGL-EM001
- 02 铝型材插条 LGL-AL005
- 03 40MM插接板 LGL40T7DS4800
- 04 铝型材连接框 LGL-AL004

底框安装爆炸效果图

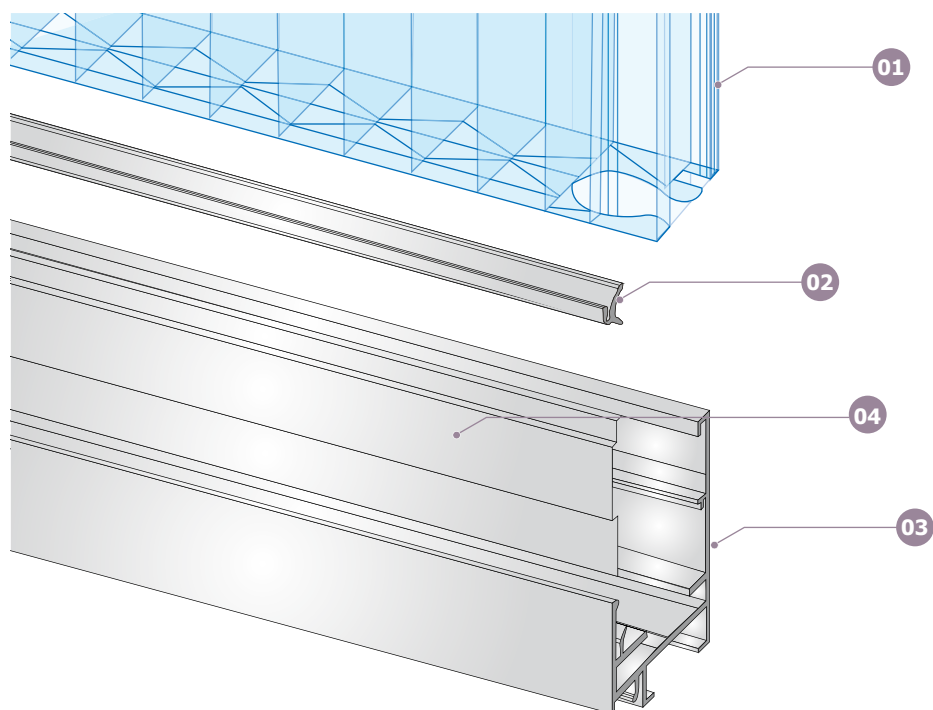

底框安装剖面效果图

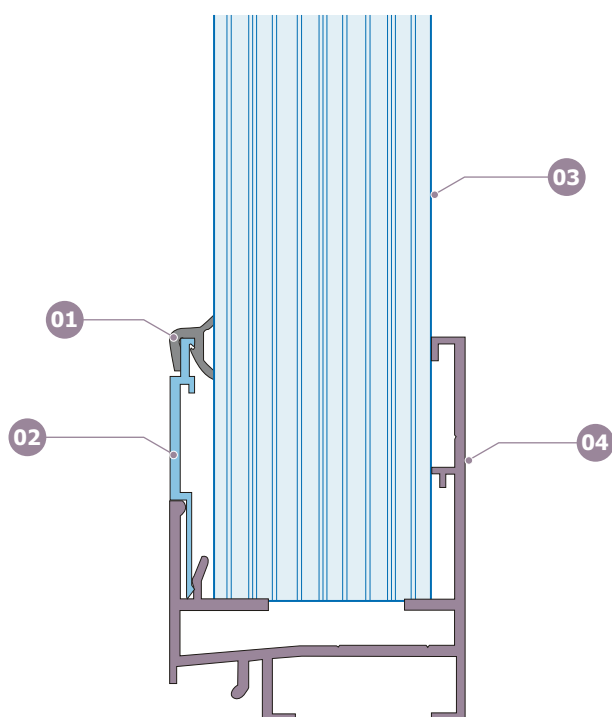

- 01 橡胶条 LGL-EM001
- 02 铝型材插条 LGL-AL009
- 03 40MM插接板 LGL40T7DS4800
- 04 铝型材连底框 LGL-AL008

安装配件结构图 Profiles

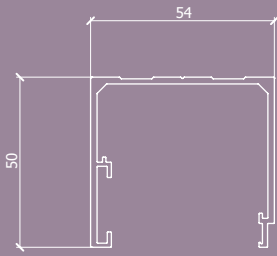

50mm铝型材
单体上框
LGL40T-AL010
850g/m

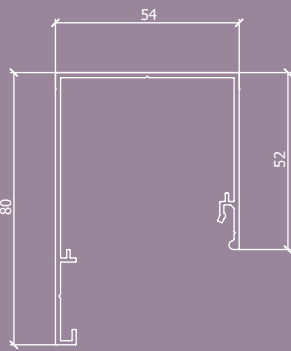

80mm铝型材
上框
LGL40T-AL002
850g/m

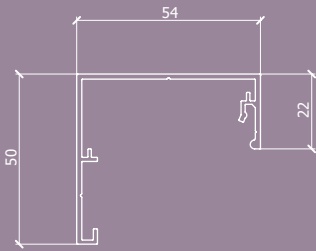

50mm铝型材
上框
LGL40T-AL003
600g/m

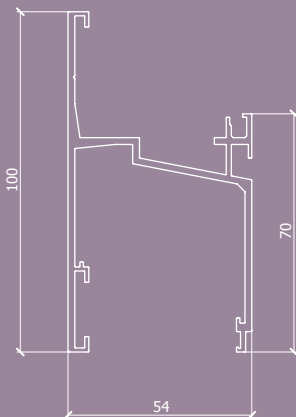

100mm
铝型材连接框
LGL40T-AL004
1420g/m

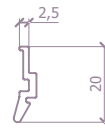

铝型材连接框
插条
LGL40T-AL005
130g/m
单配:AL004

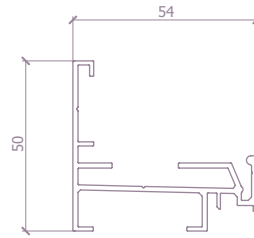

50mm铝型材
下框
LGL40T-AL006
760g/m

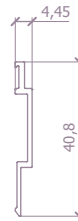

铝型材插条
LGL40T-AL007
150g/m
配:AL003/AL006/
AL002

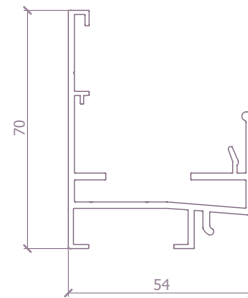

70mm铝型材
底框
LGL40T-AL008
1085g/m

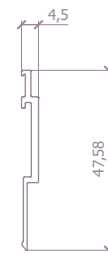

铝型材底框
插条
LGL40T-AL009
220g/m
单配:AL008

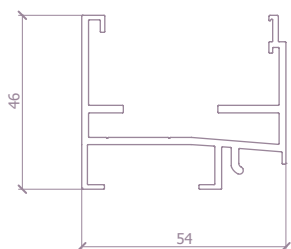

46mm铝型材
单体底框
LGL40T-AL010
950g/m

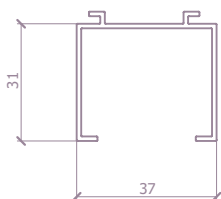

铝型材底框
固定条
LGL40T-AL011
380g/m

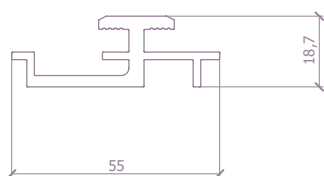

铝型材固定座
LGL40T-AL012



橡胶条
LGL40T-EM001



防尘胶带
Anti-dust Tape
JD1001

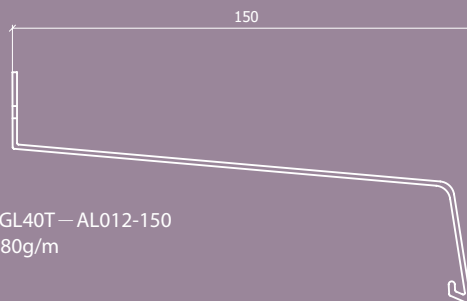

LGL40T—AL012-150
880g/m

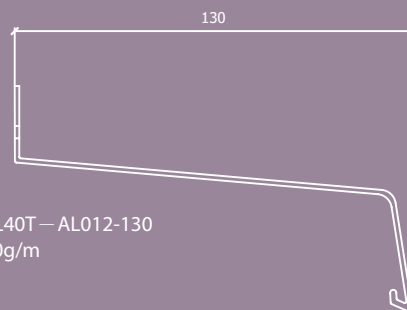

LGL40T—AL012-130
800g/m

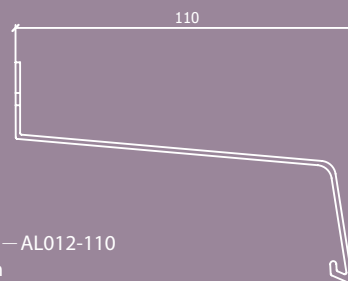

LGL40T—AL012-110
720g/m

4.2圆头自攻螺钉
Pan Head Tapping Screw
T2002



T4.8钻尾锁紧螺钉
Self-drilling Thread
Forming Screw
T2001



5.2圆头自攻螺钉
Pan Head Tapping Screw
T2003





Ideas for Growth

LiXin® Permanent
Excellent Quality
Just Need Time to Prove

历新® PC强力结构 7层插接板 (W500)

Plug-pattern Sheet (PPS)



海宁市正兴耐力板有限公司

HAINING GENSIN PLASTIC SHEET CO.,LTD.

地址: 浙江海宁斜桥工业园区新光路6号

Add: NO.6 Xinguang Road, Xieqiao Industrial Park,
Haining, Zhejiang, China

Tel: +86 573 87780888 Fax: +86 573 87781991

Hotline: 400 666 1197

Web: www.gensin.com email: gensin@gensin-co.com



产品责任条款:

本信息和我公司的技术建议,无论是口头的、书面的,还是以试验的形式,都是出于诚意而提供,对此,我公司并不作任何保证,这同样适用于涉及第三方所有权的情形。我公司的技术建议并不免除贵方验证当前所提供的信息(特别是我公司安全资料和技术信息表中的信息),并对产品按照特定的工艺和用途进行适应性测试的义务。对产品的应用、使用和加工,以及按照我公司的技术建议由贵方生产的产品是我公司不能控制的,因此,完全是贵方的责任。我公司的产品依照我公司现行有效的销售与交付的一般条款进行销售。

Cat.2015. PPS

